

Kommander T3

Multimedia Server

(General version)

Version: v2.0

Release date: 2023/05



Specifications



Hunan Bowan Technology Co. LTD

Innovative technology only for a better vision

Web: www.kommander.com.cn/en

Revision History

Version No.	Description	Revise date
V1.0	First release	2022/02/14
V2.0	Update the product picture and hardware parameters	2023/05/25

CONTENTS

1. Overview	3
2. Features	4
3. Specifications	6
4. System Topology	8
5. Dimensional View	9
6. Encoding Methods for Resolution	10
7. Media Formats	11
8. Reference for Material Production	12

1. Overview

Kommander-T3 is a multimedia software with unlimited output and layers produced by Bowan Technology. It is mainly used for splicing and synchronous control of screens and special-shaped screen. With innovative technologies such as 8K hardware decoding, pre-compiled, virtual screen management etc., T3 can easily realize the application of medium and large-scale stage performances and conference activities.



2. Features

- 4 *DP output, support 8K pixel-to-pixel smoothly display.
- 1*DVI monitor output.
- Hardware decoding for excellent rendering capabilities and performance.
- Unlimited layers and outputs.
- Projector calibration and blending, support save the blending template.
- Subtitles, teleprompter, countdown and other practical tools.
- Multi-connection, realize the cascade of multiple devices with large screens.
- Support MIDI, DMX, OSC, Stream Deck, Companion.
- Input and output of timecode. Integrated control of sound and light.
- Convert various files into playable formats.
- Editing the plan without affecting the real-time output.
- Split physical layout and reorganize according to real layout.
- Various special effects.
- Real-time synchronization of the master and backup outputs.
- Automatically backup project files during the editing.
- Support NDI, Spout virtual output (Support NDI 5, Spout1).

- Supports display PowerPoint and PDF directly, support PowerPoint animation.
- Customize layout of GUI.
- Pad control with Kommander **central control system.** (Both Android and IOS).
- 2 programming methods: timeline and plan, provides convenient functions such as plan jump, time cut, and shortcut.
- Supports UDP protocol and sending instructions to other devices.
- User-friendly panel design, monitoring operating status, including CPU, RAM, output, etc.
- Linkage control with splicer and console to achieve scene switching.

3. Specifications

Front Panel

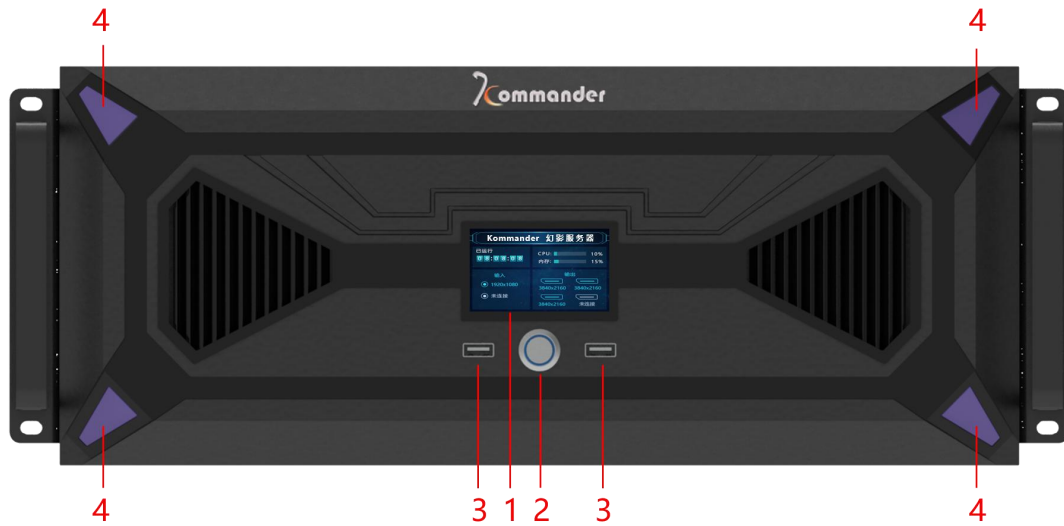

No.	Item	Description
1	Full-color LCD performance monitor screen	Display information of media server
2	Power	Power on and off
3	USB 3.0	Connect mouse, keyboard, U-disk, etc.
4	Front panel light	Appearance light

Back Panel

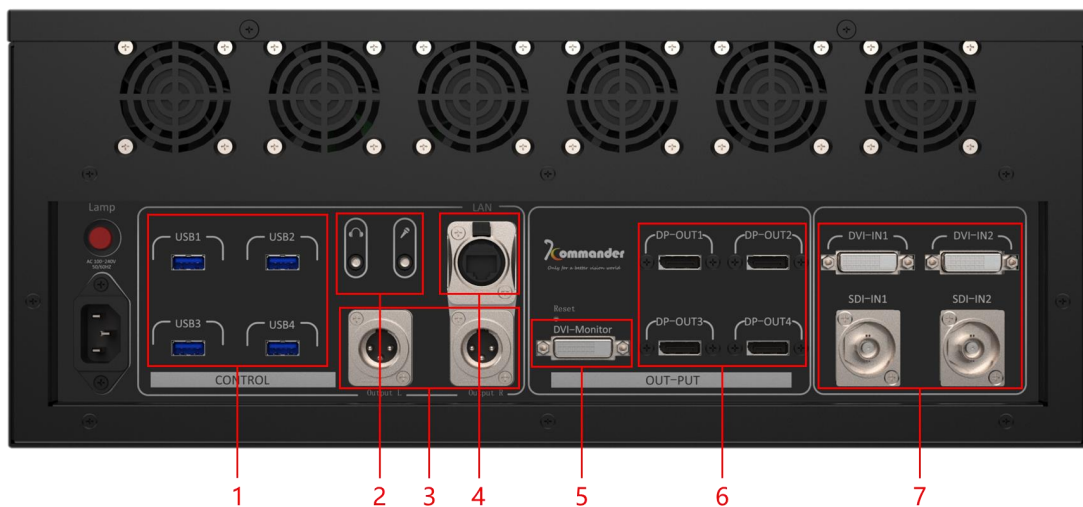

Interface Information			
No.	Item	Qty	Description
1	USB 3.0	4	USB 3.0×4
2	3.5mmAudio	2	Headphone output Microphone input, LTC timecode input
3	XLR	2	XLR output, built-in isolation
4	RJ-45	1	1000M
5	DVI-Monitor	1	Max. support 1920*1080@60Hz
6	DP 1.4	4	Max. support 3840*2400@60Hz or 4096*2160@60Hz
7	Capture Card	2	DVI Max. input 1920*1080@60Hz SDI Max. output 1920*1080@60Hz *A single capture card only supports one DVI or SDI input and supports interface customization.

*Interface differences caused by hardware upgrades will not be notified separately.

Hardware Information	
CPU	Intel Core
Mother Board	ASUS
RAM	DDR4 32G High-speed
SSD	512G M.2 High-speed SSD (expandable)
Graphics Card	Quadro 5G
Power Supply	Standard
Audio	XLR
Flight Case	Kommander custom flight case

Machine Description	
Power supply	100-240V AC~50/60Hz
Operating temperature	0-45°C
Size	572×483×177mm (L*W*H)
Net Weight	15KG
Consumption	750W

4. System Topology

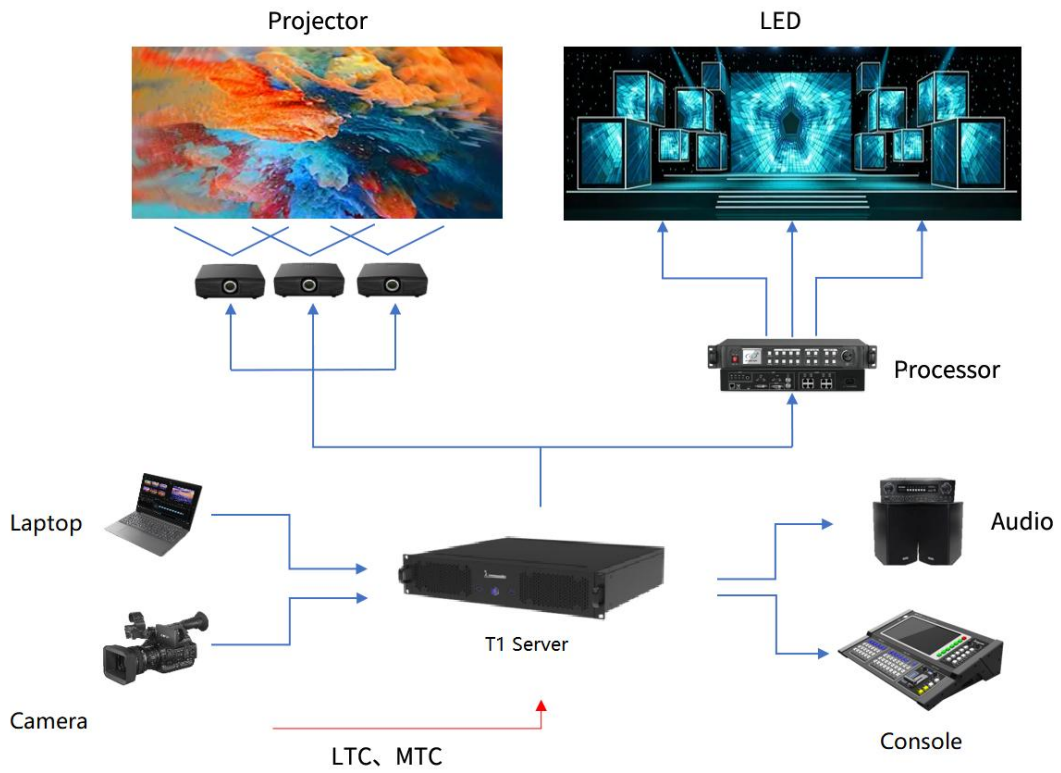

5. Dimensional View

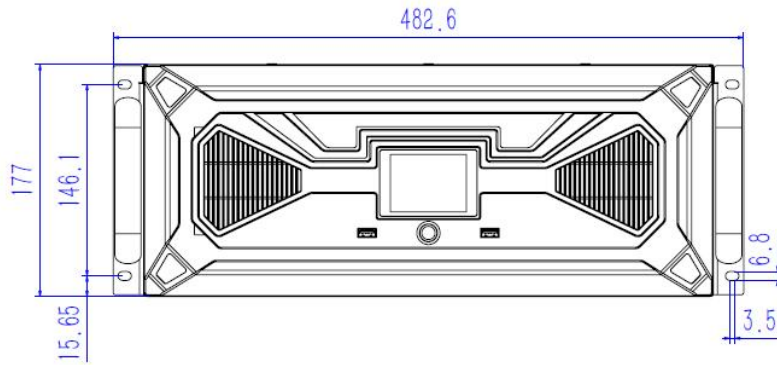

Front View

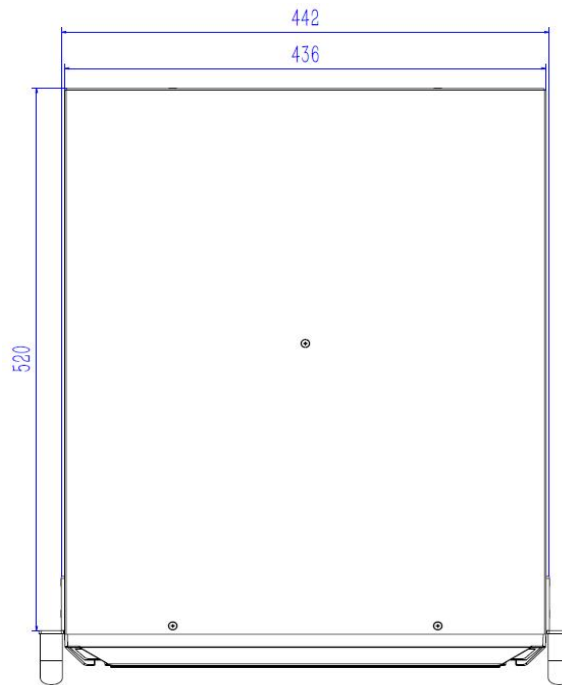

Top View

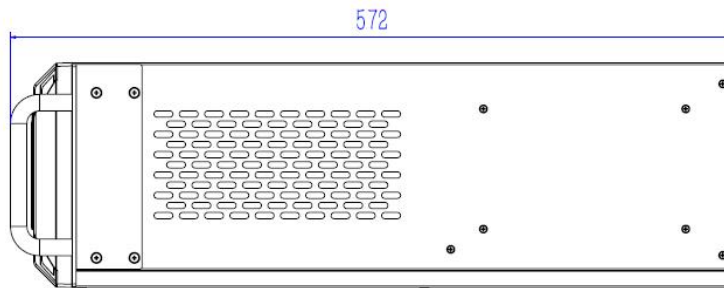

Side View

6.Encoding Methods for Resolution

Encoding Methods for Resolution	
4k	Format: H264, H265; Resolution upper limit: maximum width 4096, and maximum height 4096
8k	Format: H265, Vp9; Resolution upper limit: maximum width 8192 and maximum height 8192

w

File Formats	
Encoding Format	AVC, HEVC, VP8, VP9, mpeg-1,mpeg-2
Package Format	mp4、 mov
Color Space	yuv420p *Hardware decoding does not apply to yuv444、 yuv422、 rgb
Color Depth	8bit

7. Media Formats

Media	Format
Video	MP4, AVI, MKV, WMV, FLV, MOV, ASF, MPEG, MPG, TP, TS, MTS, M2TS, VOB, RMVB, RM, RAM, DIVX, EVO, OGM, M1V, M4V, MPE, 3GP, WEBM, KRAWF, KTESTF
Picture	JPG, JPEG, GIF, BMP, PNG, TIF, TIFF, ICO
Audio	MP3, MP2, MPA, AAC, OGG, WAV, WMA, APE, AC3, FLAC, M1A, M2A, M4A, RA, DTS, DTSHD

8. Reference for Material Production

Reference for video production

Resolution	Frame Rate	Type	Coding Methods	Pixel Format	Graphics Card	Remark
		JPG		YUV420/YUV444		The width and height of picture are supposed to be within 16K, otherwise it should be reorganized.
		JPG image frame		YUV420/YUV444		Video will be better when the resolution exceeds 4K.
1080P	30FPS	MP4	H264	YUV420	P2200	Code rate: 10M
	60FPS	MP4	H264	YUV420	P2200	Code rate: 20M
4K	30FPS	MP4	H264	YUV420	P2200	Code rate: 40M
	60FPS	MP4	H264	YUV420	P2200	Code rate: 80M
		MOV	HAP		P2200	The HAP code rate is immutable. The width and height should be aligned to an integer multiple of 16.
8K	30FPS	MP4	H265	YUV420	RTX4000	Code rate: 80M
	60FPS	MP4	H265	YUV420	RTX5000	Code rate: 160M, Frame rate will be decreased for the high reproduction.
	30FPS	MOV	HAP		RTX5000	The HAP code rate is immutable. The width and height should be aligned to an integer multiple of 16.

*For materials exceeding 8K, it is recommended to split them into multiple files.

Reference for audio production

Coding Format	Format	Rate	Remark
ACC	S16	44100/48000	If there are more than 8 channels, it is recommended to divide them into multiple files.

Copyright © 2024 Hunan Bowan Technology Co., Ltd. All rights reserved.

Without the written permission of Hunan Bowan Technology Co., Ltd, any company or individual shall not excerpt or copy part or all of the contents of this document, or disseminate it in any form.

Trademark Statement

 is a registered trademark of Bowan Technology.

Statement

Thank you for choosing the products of Hunan Bowan Technology Co., Ltd. We will be very pleased if this document brings help and convenience to your understanding and use of the products. We strive to be accurate and reliable when writing this document, and the content may be modified or changed at any time without prior notice. If you encounter any problems during use or have good suggestions, please contact us according to the contact information provided in the document. We will try our best to provide support for the problems you encounter. We sincerely appreciate your suggestions and will evaluate and adopt them as soon as possible.



Hunan Bowan Technology Co. LTD

Innovative technology only for a better vision

Web: www.kommander.com.cn/en